

Multifunctional kitchen faucet

Installation instruction

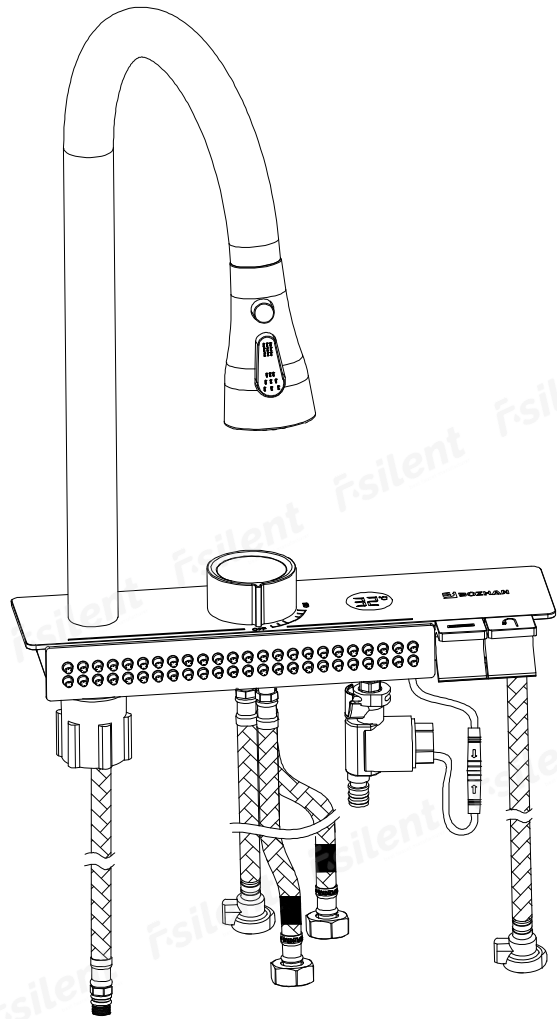

**Please specify the color number when ordering

Before installation

All information is based on the latest published product information. The Company reserves the right to change product features, packaging or types of products available at any time without notice. The instructions include important information on installation, maintenance and cleaning. Please give them to the user for reading.

Note:

1. Be sure to rinse the water supply pipe thoroughly first to remove impurities in the pipe
2. If you are installing a new wash basin, install the faucet on the wash basin first.
3. Shower working pressure: 0.1Mpa to 0.5Mpa. When the water pressure exceeds 0.5Mpa, a reducing valve must be installed. Maximum working temperature and ambient temperature of shower: 60°C. Please make special note that the arm tube connected with the shower flush must be kept away from the heater, otherwise the shower and its seal may be damaged or even harm the user.





Instructions for use

Hand wheel switch, turn fixed temperature cold water-mixed water-hot water to the right; turn left to close the water main switch. The left button controls the water mode.

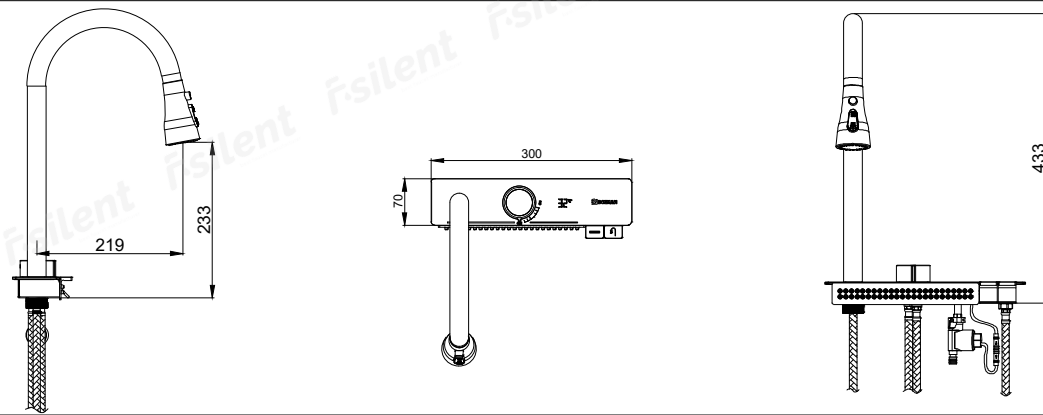
* Hand wheel is the main switch, anti-green pressure (2.5MPa) must be closed every time after use. If there is not known to cause loss, the company will not be responsible

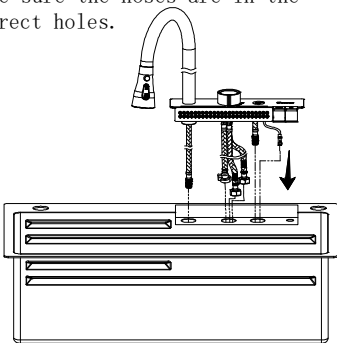
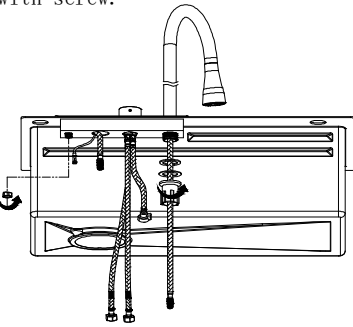
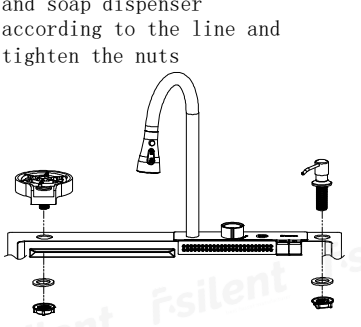
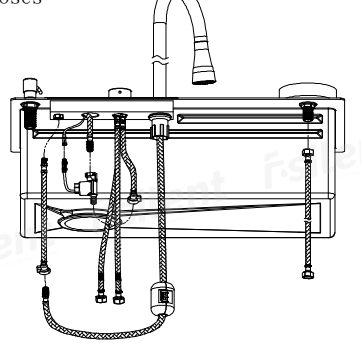
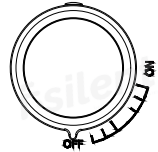
Mounting dimension

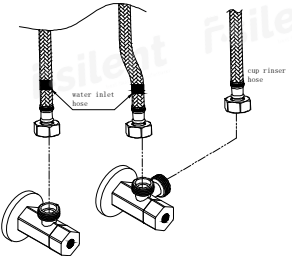
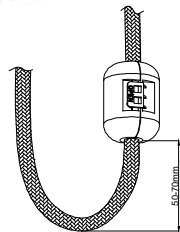
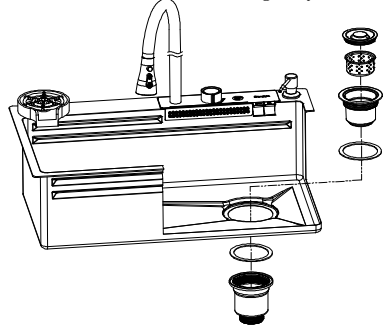
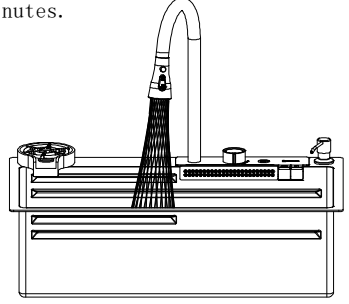

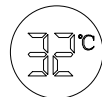
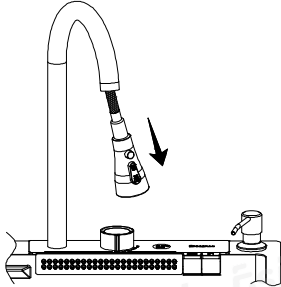
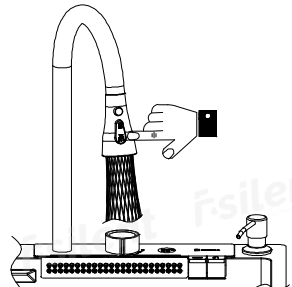
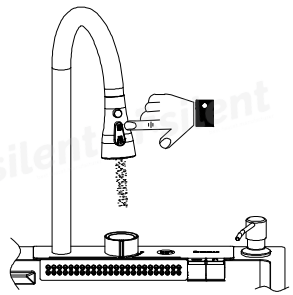
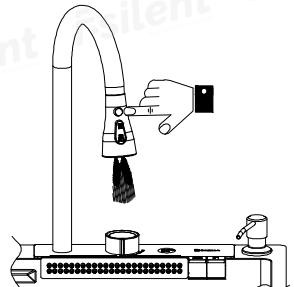
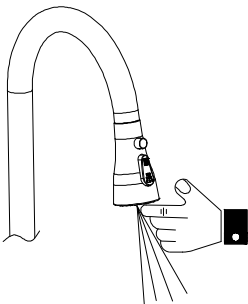
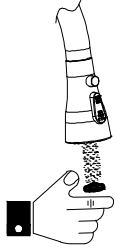
<p>1. Put the faucet body onto the sink, make sure the hoses are in the correct holes.</p> 	<p>2. Fix the faucet to the sink with screw.</p> 	<p>3. Install the cup rinser and soap dispenser according to the line and tighten the nuts</p> 	<p>4. Connect the generator and all hoses</p> 	 <p>Hand wheel, turn right for mixed water, and turn left to turn off. Turn it off after each use</p>	 <p>Soap dispenser press key</p>	 <p>Spray head button</p>
<p>5. Connect blue hose to Cold water and red hose to hot water.</p> 	<p>6. Install the gravity ball.</p> 	<p>7. Install the drain according to the line and lock it tightly</p> 	<p>8. Turn on the hot and cold water and tap switch and hand wheel, let water flow out for two minutes.</p> 	 <p>Rain water button</p>	 <p>Digital screen, displays the temperature</p>	
<p>Free drawing of pulling head</p> 	<p>Press to switch shower water</p> 	<p>Press to switch aerator</p> 	<p>Press to switch boost water</p> 			
<p>Faucet maintenance: 1: Turn on the faucet and rub the nozzle to clean up impurities.</p> 	<p>2: When the flow decreases, remove the aerator, clean and then reinstall it.</p> 			<p>Installation completion check Check and ensure that all joints are tight and hand wheel is in closed position. Turn on the main water and drainage systems, check and repair leaky interfaces</p> <p>Cleaning instruction Not for all processed surfaces: Wash the coated surface with neutral soapy water and dry the entire surface thoroughly with a clean soft cloth. Many cleaners such as ammonia, detergent powder, toilet cleaner etc.. will cause damage to the coating surface, should not be used. Wear cleaning appliances or cleaners should not be used on faucets and accessories.</p>		